

# Cobra® microTALK

Owner's Manual

For more information or to  
order any of our products,  
please visit our website:

[www.cobra.com](http://www.cobra.com)

## TWO-WAY RADIO MODEL CXR920

Printed in China  
Part No. 480-499-P  
Version C

Nothing Comes Close to a Cobra®

English

Nothing Comes Close to a Cobra®

English



Introduction

## Making Life Easier and Safer

Staying in touch with your family and friends is convenient and easy when using your microTALK® radio. Some of the many uses you will discover include: Communicating with others while hiking, biking and working; keeping track of family and friends at a crowded public event; checking with travel companions in another car; talking with neighbors; arranging meeting spots with others while shopping at the mall.

Belt Clip



### Secure your microTALK® radio while on the go.

Carrying your microTALK® radio with you is easy when using the belt clip.

The belt clip easily attaches to your belt, purse or backpack.



Customer Assistance

### For Assistance in the U.S.A.

In this user's manual, you should find all the information you need to operate your microTALK® radio. If you require further assistance after reading this manual, Cobra Electronics offers the following customer assistance services:

#### Automated Help Desk

English only. 24 hours a day, 7 days a week 773-889-3087 (phone).

#### Customer Assistance Operators

English and Spanish. 8:00 a.m. to 5:30 p.m. Central Time, Monday through Friday (except holidays) 773-889-3087 (phone).

#### Questions

English and Spanish. Faxes can be received at 773-622-2269 (fax).

#### Technical Assistance

English only. [www.cobra.com](http://www.cobra.com) (on-line: Frequently Asked Questions). English and Spanish. [productinfo@cobra.com](mailto:productinfo@cobra.com) (e-mail).

### For Assistance Outside the U.S.A.

Contact Your Local Dealer

A1

©2008 Cobra Electronics Corporation™  
6500 West Cortland Street  
Chicago, Illinois 60707 USA  
[www.cobra.com](http://www.cobra.com)

## Product Features

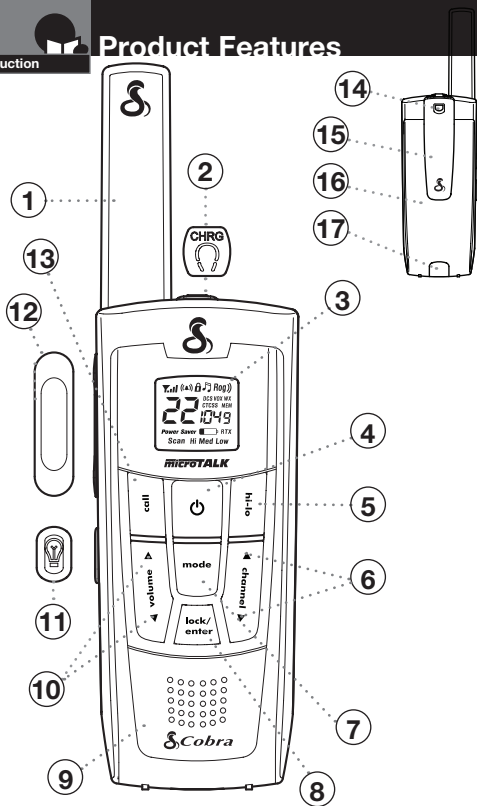

- |  |                            |
|--|----------------------------|
| 1. Antenna                                     | 9. Speaker/Microphone      |
| 2. External Speaker/<br>Microphone/Charge Jack | 10. Volume Up/Down Buttons |
| 3. Backlit LCD Display                         | 11. Light/Max Range Button |
| 4. On/Off Power Button                         | 12. Talk Button            |
| 5. Hi-Low Power Button                         | 13. Call Button            |
| 6. Channel Up/Down Buttons                     | 14. Wrist Strap Connector  |
| 7. Mode Button                                 | 15. Belt Clip              |
| 8. Lock/Enter Button                           | 16. Battery Compartment    |
|  | 17. Battery Door Latch     |

## Product Features

## Features

- **22 Channels**  
Seven shared with FRS/GMRS, seven FRS only, eight GMRS only
- **10 Channel NOAA ALL Hazards Radio**
- **142 Privacy Codes**  
(38 CTCSS codes/104 DCS codes)
- **Hands-Free Operation (VOX)**
- **VibrAlert® Silent Paging**
- **10 Channel Memory**
- **Signal Strength Meter**
- **Scan**  
Channels, privacy codes, memory
- **Selectable Hi•Med•Low Power**  
In GMRS
- **Backlit LCD Display**
- **Button Lock**
- **Call Alert**  
10 selectable tones
- **Speaker/Microphone/Charge Jack**
- **Roger Beep**  
Selectable on/off
- **Battery/Power Saver**  
Selectable on/off
- **Keystroke Tones**  
Selectable on/off
- **Auto Squelch**
- **Maximum Range Extender**
- **Belt Clip**

## Backlit LCD Display

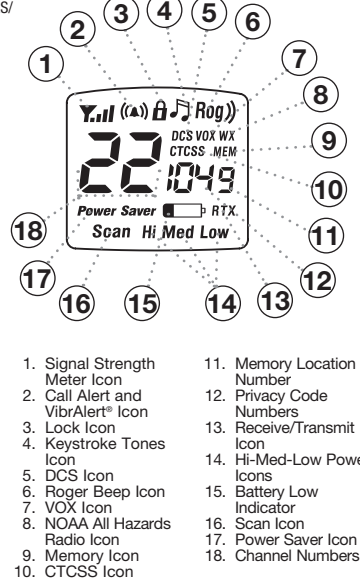

- |                                   |                            |
|-----------------------------------|----------------------------|
| 1. Signal Strength Meter Icon     | 11. Memory Location Number |
| 2. Call Alert and VibrAlert® Icon | 12. Privacy Code Numbers   |
| 3. Lock Icon                      | 13. Receive/Transmit Icon  |
| 4. Keystroke Tones                | 14. Hi-Med-Low Power Icons |
| 5. DCS Icon                       | 15. Battery Low Indicator  |
| 6. Roger Beep Icon                | 16. Scan Icon              |
| 7. VOX Icon                       | 17. Power Saver Icon       |
| 8. NOAA All Hazards Radio Icon    | 18. Channel Numbers        |
| 9. Memory Icon                    |                            |
| 10. CTCSS Icon                    |                            |



Maximum range may vary and is based on unobstructed line-of-sight communication under ideal conditions.



## Important FCC Licensing Information

This radio operates on General Mobile Radio Service (GMRS) frequencies which require a Federal Communications Commission (FCC) license. See page 27 for licensing and other related information.

## Warranty and Trademark Acknowledgement

## Limited One-Year Warranty on Radio(s) &amp; Charger

## For Products Purchased in the U.S.A.

Cobra Electronics Corporation warrants that its Cobra microTALK® radios and charger, and the component parts thereof, will be free of defects in workmanship and materials for a period of one year from the date of first consumer purchase. This warranty may be enforced by the first consumer purchaser, provided that the product is utilized within the U.S.A.

Cobra will, without charge, repair or replace, at its option, defective microTALK® radios, chargers, products or component parts upon delivery to the Cobra Factory Service department, accompanied by proof of the date of first consumer purchase, such as a duplicated copy of a sales receipt.

You must pay any initial shipping charges required to ship the product for warranty service, but the return charges will be at Cobra's expense, if the product is repaired or replaced under warranty. This warranty gives you specific legal rights, and you may also have other rights which may vary from state to state.

**Exclusions: This limited warranty does not apply:** 1) To any product damaged by accident; 2) In the event of misuse or abuse of the product or as a result of unauthorized alterations or repairs; 3) If the serial number has been altered, defaced, or removed; 4) If the owner of the product resides outside the U.S.A.

All implied warranties, including warranties of merchantability and fitness for a particular purpose are limited in duration to the length of this warranty. Cobra shall not be liable for any incidental, consequential or other damages; including, without limitation, damages resulting from loss of use or cost of installation.

Some states do not allow limitations on how long an implied warranty lasts and/or do not allow the exclusion or limitation of incidental or consequential damages, so the above limitations may not apply to you.

## For Products Purchased Outside the U.S.A.

Please contact your local dealer for warranty information.

## 90-Day Warranty on Cobra Lithium Ion Rechargeable Battery Packs and Earbud Microphones

For products purchased in the U.S.A. and Canada.

## Trademark Acknowledgement

Cobra®, microTALK®, Nothing Comes Close to a Cobra®, VibrAlert® and the snake design are registered trademarks of Cobra Electronics Corporation, USA. Cobra Electronics Corporation™ is a trademark of Cobra Electronics Corporation, USA.

## Caring for Your microTALK® Radio

Your microTALK® radio will give you years of trouble-free service if cared for properly. Handle the radio gently. Keep the radio away from dust. Never put the radio in water or in a damp place. Avoid exposure to extreme temperatures.

### Remove Belt Clip



### Pull Down Latch

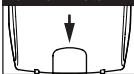

### Insert Battery Pack



## Rechargeable Battery Pack and Desktop Charger

### To install or replace battery pack:

1. Remove belt clip by releasing belt clip latch and sliding clip up.
2. Pull down on the battery door latch to remove the battery compartment cover.
3. Insert lithium ion battery pack. Position battery pack as shown in radio.
4. Replace battery compartment cover and belt clip.

### Estimated operation time on full charge: 12 hours.

Rechargeable battery packs must be recycled or disposed of properly in compliance with all applicable laws. They may not be thrown in the trash.

Certain states or municipalities require recycling and have established collection programs. Please contact your local waste removal authority for instructions, or return to Cobra for recycling.

Wrap battery packs carefully and mail postage prepaid to: Cobra Electronics Corporation, 6500 West Cortland Street, Chicago, IL 60707 USA, Attn: Battery Recycling.



Do not put battery packs into fire or expose to high heat. They may explode.

# Using Your Radio

## Insert Radio(s)

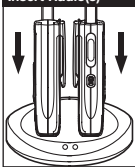

For charging microTALK® radio(s) in desktop charger:

1. Insert radio(s) into desktop charger as shown.
2. Insert round connector of 120-volt adapter into jack on back of charger.
3. Plug 120-volt adapter into electrical outlet.

If charging light is not **on**, check position of radio. Radio should be upright. The charge indicator light will stay **on** as long as the radio is in the charging well and the battery pack is charging. After the battery pack is fully charged, the charge indicator light will turn **off**.

It normally takes about 15 hours to fully recharge battery pack. Battery pack will not be damaged if they stay in the charging well longer than that.



To charge a single radio, you can bypass the desktop charger and simply insert the wall adapter's round connector directly into the speaker/microphone/charge jack located on the top of the radio.

Use only the supplied rechargeable batteries and charger for recharging your Cobra microTALK® radio.

Cobra recommends your radio is turned **off** while being charged.



## Quick Start

1. Press and hold the **Power** button to turn **on** your radio.
2. Press the **Channel Up** or **Channel Down** button to select a channel.



Both radios must be tuned to the same channel/privacy code to communicate.

3. Press and hold the **Talk** button while speaking into the microphone.
4. When finished talking, release the **Talk** button and listen for a response.

## On/Off Power



## Turning on Your microTALK® Radio

Press and hold the **Power** button until you hear a series of audible tones indicating the radio is **on**.

Your microTALK® radio is now in **Standby** mode, ready to receive transmissions. The radio is always in **Standby** mode, except when the **Talk**, **Call**, **Mode** or **Power** buttons are pressed.

## Battery Low



## Battery Low

When battery power is low, the **Battery Low** icon will blink. Your batteries should be recharged.

## Battery Save Mode



## Auto Battery Save

Your microTALK® radio has a unique circuit designed to extend battery life. If there are no transmissions for 10 seconds, the radio will automatically switch to **Battery Save** mode and the **Power Saver** icon will flash in the display. This will not affect the radio's ability to receive incoming transmissions.

## Talk Button



## Two Inches (5 cm) from Mouth



## Communicating with Another Person

1. Press and hold the **Talk** button.
2. With the microphone about 2 inches (5 cm) from your mouth, speak in a normal voice.
3. Release the **Talk** button when you are finished talking and listen for a response.

You cannot receive incoming calls while pressing the **Talk** button.



Both radios must be tuned to the same channel/privacy code to communicate.

## Channel Buttons



## Channels

With the radio **on**, select any of the 22 channels by pressing the **Channel Up** or **Channel Down** button.

## Channel Number



Both radios must be tuned to the same channel to communicate.

Channels 1 through 7 are shared by FRS and GMRS. Channels 8 through 14 are FRS only. Channels 15 through 22 are GMRS only.

See page 26 for FRS/GMRS frequency allocations and compatibility charts.

## Listening



## Listening for a Response

Release the **Talk** button to receive incoming transmissions. Your microTALK® radio is always in **Standby** mode while the **Talk** or **Call** buttons are not pressed.

## Call Button



## Call Button

**To alert another person that you are calling:**

– Press and release the **Call** button.

The other person will hear a two (2) second call tone. This tone is used only to establish voice communications.

See page 24 on how to select from 10 available call tone settings.

## Light/Max Range



## To Illuminate Display

Press and release the **Light/Max Range** button to illuminate the display for 10 seconds.

## Talk Button



## Time-out Timer

The Time-out Timer feature limits transmit time to three (3) continuous minutes to extend battery life and prevent accidental operation. After three (3) continuous minutes of transmission, the radio will stop transmitting and will require a rest period of 30 seconds. During this time the display will flash on and off, and an error tone will sound if the **Push-to-Talk** button is pressed.

## Hi-Low Button



## Selectable High•Medium•Low Power Output

When in close proximity to another party or during favorable conditions, you can switch from **High** to **Medium** to **Low Power** to extend battery life.

## Hi Power Icon



This feature applies to GMRS Channels 1 through 7 and 15 through 22 only. Channels 8 through 14 operate exclusively on low power.

## Medium Power Icon



**To switch from high to medium to low power:**

– Press and release the **Hi•Low** button.

When in High Power and using Channels 1 through 7 and 15 through 22, the **Hi** icon will be visible in the LCD display.

## Low Power Icon



When in Medium Power and using Channels 1 through 7 and 15 through 22, the **Med** icon will be visible in the LCD.

When in Low Power or while using channels 8 through 14, the **Low** icon will be visible in the display.

When using an external speaker/microphone accessory on channels 1-7 or 15-22, your microTALK® radio will only operate on medium or low power.

## Auto Squelch/Maximum Range

Your microTALK® radio is equipped with **Auto Squelch**, which automatically shuts **off** weak transmissions and unwanted noise due to terrain and conditions. This slightly reduces the **Maximum Range** at which signals can be heard.

You can turn **off** auto squelch to allow all signals to be received and extend the maximum range of your radio.

### Light/Max Range



#### To briefly turn off auto squelch:

- Press the **Light/Max Range** button for less than five (5) seconds.

If you hear two (2) beeps, you have turned the maximum range extender **on** (see below).

#### To turn maximum range extender on:

- Press and hold the **Light/Max Range** button for at least five (5) seconds until you hear two (2) beeps which indicates the maximum range extender is **on**.

#### To turn maximum range extender off:

- Press and release the **Light/Max Range** button or change channels.

## Lock Feature

The **Lock** feature locks the **Channel**, **Mode**, **Hi•Low** and **Power** buttons to prevent accidental operation.

### Lock/Enter Button

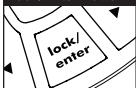

#### To turn the lock feature on or off:

- Press and hold the **Lock/Enter** button for two (2) seconds.

A double beep sound is used to confirm your lock **on** or **off** request. When in **Lock** mode, the **Lock** icon will be displayed.

### Lock Mode



## Speaker/Microphone/Charge Jack

Your microTALK® radio can be fitted with an external **Speaker/Microphone**, freeing your hands for other tasks. This same jack also serves as the connecting point for the wall charger/adapter.

### Speaker/Microphone/Charge Jack



#### To attach a speaker/microphone:

1. Open the speaker/microphone/charge tab on top of your microTALK® radio.
2. Insert the plug into the speaker/microphone/charge jack. (See page 5 for power output settings while using speaker/microphones.)

#### To connect a wall charger/adapter:

1. Open the speaker/microphone/charge tab on top of your microTALK® radio.
2. Insert the wall charger/adapter plug into the speaker/microphone/charge jack.

### Radio Charger Jack



### Placed in Ear



### Clipped to Clothing



## Earbud Microphone

1. Plug earbud microphone into radio.
2. Place earbud in ear.
3. Clip microphone onto clothing 3" to 6" from your mouth.
4. Push to talk.

### Push to Talk

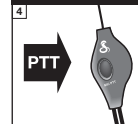

### Signal Strength



## Signal Strength Meter

Your microTALK® radio has a **Signal Strength Meter** that shows the strength of your incoming and outgoing transmissions. The ascending bars next to the signal strength indicate the strength of the signal. The greater the number of bars visible, the stronger the signal. The fewer number of bars visible, the weaker the signal.

## Scrolling through Mode Functions

By scrolling through the **Mode Functions**, you will be able to select or turn **on/off** preferred features of your microTALK® radio. When scrolling through the **Mode Functions**, your radio features will be displayed in the following order:

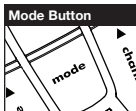

- Set CTCSS Privacy Codes
- Set DCS Privacy Codes
- Set NOAA All Hazards Radio Channel
- Set VOX On/Off
- Set VOX Sensitivity Level
- Set Memory Locations
- Set Channel Scan
- Set CTCSS Privacy Code Scan
- Set DCS Privacy Code Scan
- Set Memory Location Scan
- Set VibrAlert® and/or Call Alert
- Set Call Alert Tone Signal
- Set Roger Beep On/Off
- Set Keystroke Tones On/Off

Scroll through the mode functions using the **Mode** button. Each press and release of the **Mode** button will advance to the next mode function. Press the **Talk** button at any point to return the radio to **Standby** mode.

## Privacy Codes

Your microTALK® radio incorporates two (2) advanced coded squelch systems that can help to reduce interference from other users on any given channel. CTCSS (Continuous Tone Coded Squelch System) provides 38 privacy codes and DCS (Digitally Coded Squelch) provides 104 privacy codes. This provides a total of 142 **Privacy Codes**. Either system can be used on all channels, but both systems cannot be used on the same channel at the same time.



To successfully communicate using a privacy code, both the sending and receiving radios must be tuned to the same channel and to the same privacy code system (CTCSS or DCS) and privacy code number. Each channel will remember the last privacy code system and number you select.



The privacy code 00 is not a privacy code, but allows all signals to be heard on a channel that is set to 00 on both the CTCSS and DCS systems.

## Set CTCSS Privacy Codes

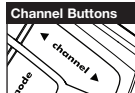
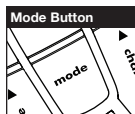

To select a CTCSS privacy code:

1. After selecting a channel, press the **Mode** button until the CTCSS icon appears and the small numbers flash on the display (01 through 38).



### NOTE

If DCS is turned **on** at the channel selected, the display will flash the CTCSS icon and "OFF." To switch from DCS to CTCSS, press the **Channel Up** or **Channel Down** button while the display is flashing "OFF." The display will then show the small numbers flashing and you will then be able to proceed to step 2.

2. Press the **Channel Up** or **Channel Down** button to select a CTCSS privacy code. You can hold the **Channel Up** or **Channel Down** button for fast advance.
3. When your desired CTCSS privacy code is displayed, choose one of the following:
  - a. Press the **Mode** button to enter the new setting and proceed to other functions.
  - b. Press the **Lock/Enter** button to enter the new setting and return to **Standby** mode.
  - c. Do not press any buttons for 15 seconds to enter the new setting and return to **Standby** mode.

## Set DCS Privacy Codes

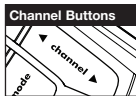
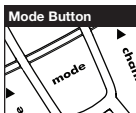

To select a DCS privacy code:

1. After selecting a channel, press the **Mode** button until the DCS icon appears and the small numbers flash on the display (01 through 104).



### NOTE

If CTCSS is turned **on** at the channel selected, the display will flash the DCS icon and "OFF." To switch from CTCSS to DCS, press the **Channel Up** or **Channel Down** button while the display is flashing "OFF." The display will then show the small numbers flashing and you will then be able to proceed to step 2.

2. Press the **Channel Up** or **Channel Down** button to select a DCS privacy code. You can hold the **Channel Up** or **Channel Down** button for fast advance.
3. When your desired DCS privacy code is displayed, choose one of the following:
  - a. Press the **Mode** button to enter the new setting and proceed to other functions.
  - b. Press the **Lock/Enter** button to enter the new setting and return to **Standby** mode.
  - c. Do not press any buttons for 15 seconds to enter the new setting and return to **Standby** mode.

## NOAA\* All Hazards Radio Channels

You can use your microTALK® radio to listen to NOAA All Hazards Radio channels transmitting in your area.

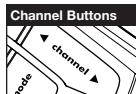
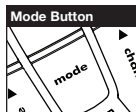

To listen to All Hazards Radio channels:

1. Press the **Mode** button until the **WX** (All Hazards Radio) icon, the currently selected All Hazards Radio channel, and signal strength are displayed.
2. Use the **Channel Up** or **Channel Down** button to change All Hazards Radio channels.
3. **WX** (All Hazards Radio) icon will continue to be displayed when All Hazards Radio is **on**. Choose one of the following:
  - a. Press the **Mode** button to proceed to other functions.
  - b. Press the **Lock/Enter** button to exit **All Hazards Radio** channels mode and return to **Standby** mode.

\*National Oceanographic and Atmospheric Administration

## microTALK® Range

Your range will vary depending on terrain and conditions.

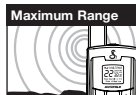

In flat, open country your radio will operate at maximum range.

Buildings and foliage in the path of the signal can reduce the range of the radio.

Dense foliage and hilly terrain will further reduce the range of the radio.

On FRS channels 8 through 14, your radio automatically switches to low power, which will limit the range the radio can communicate.



Remember, you can achieve maximum range by using maximum range extender. See page 6 for details.



## Voice Activated Transmit (VOX)

In **VOX** mode, your microTALK® radio can be used “hands-free,” automatically transmitting when you speak. You can set the **VOX** sensitivity level to fit the volume of your voice and avoid transmissions triggered by background noise.

### Mode Button



### To turn VOX mode on or off:

1. Press the **Mode** button until the **VOX** icon flashes on the display. The current **on** or **off** setting is displayed.
2. Press the **Channel Up** or **Channel Down** button to turn **VOX on** or **off**.
3. Choose one of the following:

- a. Press the **Mode** button to enter the selected **on** or **off** setting and proceed to other functions.
- b. Press the **Lock/Enter** button to enter the selected **on** or **off** setting and return to **Standby** mode.

### To set VOX sensitivity:

1. Press the **Mode** button until the **VOX** icon flashes and the current sensitivity level is displayed.



The current sensitivity level is displayed with letters “LE” and a Number 01 through 05, with Number 05 being the most sensitive level and Number 01 being the least sensitive level.

2. Press the **Channel Up** or **Channel Down** button to change the setting.
3. Choose one of the following:
  - a. Press the **Mode** button to enter the selected setting and proceed to other functions.
  - b. Press the **Lock/Enter** button to enter the selected setting and return to **Standby** mode.

### VOX Icon



### Channel Buttons



### Mode Button



## 10 Memory Locations

Your microTALK® radio has **10 Memory Locations** for storing your most frequently used channels and channel/privacy code combinations. These **Memory Locations** can be selected individually or can be scanned. (See page 21 for memory location scan.)

### Mode Button



### To program a memory location:

1. Press the **Mode** button until the **Memory** icon and the memory location flash on the display.
2. Press the **Channel Up** or **Channel Down** button to select the memory location (0 through 9).



If a location has been programmed before, its associated channel/privacy code will be shown on the display.

### Memory Icon



### Channel Buttons



### Lock/Enter Button



3. Press the **Lock/Enter** button to enter a new memory location or edit an already programmed memory location. The channel numbers will flash on the display.
4. Press the **Channel Up** or **Channel Down** button to select a channel (1 through 22).
5. Press the **Lock/Enter** button. The CTCSS icon and privacy code numbers will flash on the display.

## 6. Choose one of the following:

- a. Press the **Channel Up** or **Channel Down** button to select a CTCSS privacy code (01 through 38) for the channel.
- b. Press the **Lock/Enter** button to switch from CTCSS to DCS. The DCS icon and privacy code numbers will flash on the display. The **Channel Up** or **Channel Down** button can then be used to select a DCS privacy code (01 through 104) for the channel.



If "OFF" flashes in place of the privacy code numbers, a privacy code is already set in the opposite (CTCSS or DCS) system. Press the **Channel Up** or **Channel Down** button to cancel the opposite code and select a privacy code from the active system for the selected channel.

## 7. Choose one of the following:

- a. Press the **Lock/Enter** button to enter the channel/privacy code in the selected memory location. Radio then proceeds to next Memory location, which will blink.
- b. Press the **Mode** button to enter the channel/privacy code in the selected memory location and proceed to other functions on the channel/privacy code displayed before you entered mode functions.
- c. Press the **Talk** button to enter the channel/privacy code in the selected memory location and exit mode functions. Upon release of the **Talk** button, the radio will enter **Standby** mode on the channel/privacy code just entered.

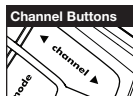
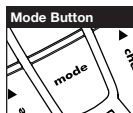

## To recall a stored memory channel location:

1. Press the **Mode** button until the **Memory** icon and the memory location number flash on the display.
2. Press the **Channel Up** or **Channel Down** button to select a memory location (0 through 9).



If a location has been programmed before, its associated channel/privacy code will be shown on the display.

3. Press the **Talk** button to return to **Standby** mode on the selected memory location.



A memory location can be reprogrammed at any time it is displayed and flashing. Press the **Lock/Enter** button to begin.

While recalling a stored memory location, if you do not press any buttons for 15 seconds, your radio will automatically return to **Standby** mode on the channel/privacy code displayed before you entered mode functions.

# Mode Functions

## Mode Button



## Memory Icon



## Channel Buttons



## Lock/Enter Button



## Channel 0



### To de-program a memory location:

1. Press the **Mode** button until the **Memory** icon and the memory location flash on the display.
2. Press the **Channel Up** or **Channel Down** button to select the memory location (0 through 9).



If a location has been programmed before, its associated channel/privacy code will be shown on the display.

3. Press the **Lock/Enter** button. The channel numbers will flash on the display.
4. Press the **Channel Up** or **Channel Down** button to select Channel 0.
5. Choose one of the following:
  - a. Press the **Lock/Enter** button to enter the channel/privacy code in the selected memory location and return to the beginning of memory location options.
  - b. Press the **Mode** button to enter the channel/privacy code in the selected memory location and proceed to other functions on the channel/privacy code displayed before you entered mode functions.

While de-programming a memory location, if you do not press any buttons for 15 seconds, your radio will automatically return to **Standby** mode on the channel/privacy code displayed before you entered mode functions.

## Channel Scan

Your microTALK® radio can automatically scan channels.

### Mode Button



### Scanning Channels



### Channel Buttons



### To scan channels:

1. Press the **Mode** button until the **Scan** icon and the channel numbers flash on the display.
2. Press the **Channel Up** or **Channel Down** button to begin scanning channels.



The radio ignores specific privacy codes while scanning channels.

The **Scan** icon will continue to be displayed when scan is **on**. Your radio will continue to scan all channels and stop if an incoming transmission is detected. Your radio will remain on that channel for 10 seconds.

While setting channel scan, if you do not press any buttons for 15 seconds, your radio will automatically return to **Standby** mode on the channel or channel/privacy code displayed before you entered mode functions.

During channel scan (while receiving an incoming transmission), you can choose from the following:

- Press and hold the **Talk** button to communicate on that channel. Your radio will remain on that channel and return to **Standby** mode.
- Press the **Channel Up** or **Channel Down** button to resume scanning channels.

If you press the **Talk** button while scanning, but more than 10 seconds after receiving a transmission, you will transmit on the channel on which you last received a transmission. This will return the radio to **Standby** mode.

If you do not press any button within 10 seconds after receiving a scanned transmission, your radio will automatically resume scanning channels.

During channel scan (while not receiving a transmission), you can choose from the following:

- Press and hold the **Talk** button to communicate on the channel or channel/privacy code that was displayed before you entered mode functions or the channel on which, during scanning, you last received a transmission. This will then return the radio to **Standby** mode.
- Press the **Mode** button to proceed to set privacy code scan on the channel that was either displayed before you entered mode functions or on which, during channel scanning, you last received a transmission (see page 19 for further details).
- Press the **Lock/Enter** button to return to **Standby** mode on the channel/privacy code that was displayed before you entered mode functions or the channel on which, during scanning, you last received a transmission.

## Privacy Code Scan

Your microTALK® radio can automatically scan the **Privacy Codes** (either CTCSS 01 through 38 or DCS 01 through 104) within one channel. Only one set of privacy codes (CTCSS or DCS) can be scanned at a time.

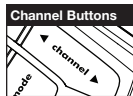
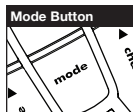

### To scan privacy codes:

- While in **Standby** mode, press the **Channel Up** or **Channel Down** button to choose the channel on which you wish to scan privacy codes.
- Press the **Mode** button until either the CTCSS or the DCS icon appears on the display and the **Scan** icon and the privacy code numbers flash on the display.
- Press the **Channel Up** or **Channel Down** button to begin scanning privacy codes within the channel you selected.

The **Scan** icon will continue to be displayed when privacy code scan is **on**. Your radio will continue to scan privacy codes and stop as an incoming transmission is detected. Your radio will remain on that channel/privacy code for 10 seconds.

While setting privacy code scan, if you do not press any buttons for 15 seconds, your radio will automatically return to **Standby** mode on the channel/privacy code that was displayed before you entered mode functions.

During privacy code scan (while receiving an incoming transmission), you can choose from the following:

- Press and hold the **Talk** button to communicate on that channel/privacy code. Your radio will remain on that channel/privacy code and return to **Standby** mode.
- Press the **Channel Up** or **Channel Down** button to resume scanning privacy codes.

If you press the **Talk** button while scanning, but more than 10 seconds after receiving a transmission, you will transmit on the channel/privacy code on which you last received a transmission. This will then return the radio to **Standby** mode.

If you do not press any button within 10 seconds, your radio will automatically resume scanning privacy codes.

During privacy code scan (while not receiving a transmission), you can choose from the following:

- Press and hold the **Talk** button to communicate on the channel/privacy code that was displayed before you entered mode functions or the channel/privacy code on which, during scanning, you last received a transmission. This will return the radio to **Standby** mode.
- Press the **Mode** button to proceed to set memory location scan (see page 21 for further details).
- Press the **Lock/Enter** button to return to **Standby** mode on the channel/privacy code that was displayed before you entered mode functions or the channel/privacy code on which, during scanning, you last received a transmission.

## Memory Location Scan

Your microTALK® radio can automatically scan up to 10 programmed **Memory Locations**.



If there are one or fewer memory locations programmed in your radio, the scan memory locations option will not be available. To program at least two (2) memory locations, see program memory locations on page 13.

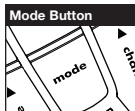

### To scan memory locations:

- Press the **Mode** button until the **Scan** icon, **Memory** icon and the memory location number flash on the display.
- Press the **Channel Up** or **Channel Down** button to begin scanning memory locations.

The **Scan** icon and the **Memory** icon will continue to be displayed when memory location scan is **on**. Your radio will continue to scan memory locations and stop if an incoming transmission is detected. Your radio will remain on that memory location for 10 seconds.

While setting memory location scan, if you do not press any buttons for 15 seconds, your radio will automatically return to **Standby** mode on the channel/privacy code displayed before you entered mode functions.

During memory location scan (while receiving an Incoming transmission), you can choose from the following:

- Press and hold the **Talk** button to communicate on that memory location.
- Your radio will remain on that memory location and return to **Standby** mode. Press the **Channel Up** or **Channel Down** button to resume scanning memory locations.
- After 10 seconds of inactivity, unit starts scan again.

If you press the **Talk** button while scanning, but more than 10 seconds after receiving a transmission, you will transmit on the memory location on which, during scanning, you last received a transmission.

If you do not press any button within 10 seconds, your radio will automatically resume scanning memory locations.

During memory location scan (while not receiving a transmission), you can choose from the following:

- Press and hold the **Talk** button to communicate on the channel/privacy code that was displayed before you entered mode functions or memory location on which, during scanning, you last received a transmission.
- Press the **Mode** button to proceed to other functions.
- Press the **Lock/Enter** button to return to **Standby** mode on the channel/privacy code that was displayed before you entered mode functions or the memory location on which, during scanning, you last received a transmission.



To reduce the number of memory locations being scanned, you may de-program any unwanted locations. (See page 16 to de-program a memory location.)

## VibrAlert® and Call Alert

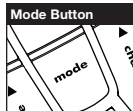
Your microTALK® radio can alert you to incoming signals by sounding an audible call tone, by vibrating silently or both.



### To change call settings:

- Press the **Mode** button until the **Call Setting** icon flashes on the display. The current setting ("01" vibrate + ring, "02" vibrate only or "03" ring only) is displayed.
 
- Press the **Channel Up** or **Channel Down** button to change the call setting.
 
- Choose one of the following:
  - Press the **Mode** button to enter the new setting and proceed to other functions.
 
  - Press the **Lock/Enter** button to enter the new setting and return to **Standby** mode.

## 10 Call Tone Settings

You can choose from 10 different call tone settings to transmit a unique call alert.

### Mode Button



To change a call tone setting:

1. Press the **Mode** button until the letter "C" and the current call tone number (01 through 10) is displayed.
2. Press the **Channel Up** or **Channel Down** button to hear the other call tone settings.
3. Choose one of the following:
  - a. Press the **Mode** button to enter the new setting and proceed to other functions.
  - b. Press the **Lock/Enter** button to enter the new setting and return to **Standby** mode.

### Call Tone Setting



### Channel Buttons



## Roger Beep Confirmation Tone

**Roger Beep** is an audible tone that your listener will hear when you release the **Talk** button. This alerts the other party that you are finished talking and it is OK for them to speak.

### Mode Button



To turn roger beep on or off:

1. Press the **Mode** button until the **Roger Beep** icon flashes on the display. The current **on** or **off** setting is displayed.
2. Press the **Channel Up** or **Channel Down** button to select roger beep **on** or **off**.
3. Choose one of the following:
  - a. Press the **Mode** button to enter the new setting and proceed to other functions.
  - b. Press the **Lock/Enter** button to enter the new setting and return to **Standby** mode.

### Roger Beep On



### Channel Buttons



## Keystroke Tones

With **Keystroke Tones** turned **on**, your radio will sound beeps each time you press a button or change a setting.

### Mode Button



To change keystroke tones:

1. Press the **Mode** button until the **Keystroke Tones** icon flashes on the display. The current **on** or **off** setting is displayed.
2. Press the **Channel Up** or **Channel Down** button to turn keystroke tones **on** or **off**.
3. Choose one of the following:
  - a. Press the **Mode** button to enter the new setting and return to **Standby** mode.
  - b. Press the **Lock/Enter** button to enter the new setting and return to **Standby** mode.

### Keystroke Tones On



### Channel Buttons





## General Specifications

### FRS/GMRS Frequency Allocation and Compatibility

**Important:** Please note that Cobra GMRS models with 15 Channels may designate different channel numbers for the same frequency. For example, a Cobra 15 Channel GMRS model would need to be tuned to Channel 11 in order to communicate with a 22 Channel GMRS tuned to Channel 15. Please refer to the chart below for channel/ frequency number compatibility.

**A = Channel No. for 22 Channel FRS/GMRS Models**

**B = Channel No. for 15 Channel GMRS Models**

**C = Type of Radio Service**

**D = Frequency in MHz**

**E = Power Output**

A	B	C	D	E
1	1	FRS/GMRS	462.5625	High, Med, or Low
2	2	FRS/GMRS	462.5875	High, Med, or Low
3	3	FRS/GMRS	462.6125	High, Med, or Low
4	4	FRS/GMRS	462.6375	High, Med, or Low
5	5	FRS/GMRS	462.6625	High, Med, or Low
6	6	FRS/GMRS	462.6875	High, Med, or Low
7	7	FRS/GMRS	462.7125	High, Med, or Low
8		FRS	467.5625	Low
9		FRS	467.5875	Low
10		FRS	467.6125	Low
11		FRS	467.6375	Low
12		FRS	467.6625	Low
13		FRS	467.6875	Low
14		FRS	467.7125	Low
15	11	GMRS	462.5500	High, Med, or Low
16	8	GMRS	462.5750	High, Med, or Low
17	12	GMRS	462.6000	High, Med, or Low
18	9	GMRS	462.6250	High, Med, or Low
19	13	GMRS	462.6500	High, Med, or Low
20	10	GMRS	462.6750	High, Med, or Low
21	14	GMRS	462.7000	High, Med, or Low
22	15	GMRS	462.7250	High, Med, or Low



## IMPORTANT NOTICE: FCC LICENSE REQUIRED

This two-way radio operates on GMRS (General Mobile Radio Service) frequencies which require an FCC (Federal Communications Commission) license. A user must be licensed prior to operating on Channels 1 through 7 on high power or 15 through 22, which comprise the GMRS channels of this radio. Serious penalties could result for unlicensed use of GMRS channels, in violation of FCC rules. Operation of this radio is subject to additional rules specified in 47 C.F.R. Part 95.

Licensed users will be issued a call sign by the FCC, which should be used for station identification when operating this radio. GMRS users should also cooperate by engaging in permissible transmissions only, avoiding channel interference with other GMRS users, and being prudent with the length of their transmission time.

For licensing information and application forms, please call the FCC Hotline at 800-418-FORM. Request form #159 and form #605. Questions regarding the license application should be directed to the FCC at 888-CALL-FCC. Additional information is available on the FCC's website at [www.fcc.gov](http://www.fcc.gov).

Channel 1 through 7 on low power and channels 8 through 14 comprise the FRS (Family Radio Service). No license is required to operate on the FRS.

### Safety Information for microTALK® Radio

Your wireless handheld portable transceiver contains a low power transmitter. When the talk button is pushed, it sends out radio frequency (RF) signals. The device is authorized to operate at a duty factor not to exceed 50%. In August 1996, the Federal Communications Commission (FCC) adopted RF exposure guidelines with safety levels for handheld wireless devices.

### Important

FCC RF Exposure Requirements: For body-worn operation, this radio has been tested and meets the FCC RF exposure guidelines when used with Cobra accessories supplied or designated for this product. Use of other accessories may not ensure compliance with FCC RF exposure guidelines. Use only the supplied antenna. Unauthorized antennas, modifications or attachments could damage the transmitter and may violate FCC regulations.

### Normal Position

Hold the transmitter approximately two inches from your face and speak in a normal voice, with the antenna pointed up and away.

This device complies with part 15 of the FCC Rules. Operation is subject to the following two conditions: 1) This device may not cause harmful interference, and 2) this device must accept any interference received, including interference that may cause undesired operation.

FCC Warnings: Replacement or substitution of transistors, regular diodes or other parts of a unique nature, with parts other than those recommended by Cobra may cause a violation of the technical regulations of part 95 of the FCC rules, or violation of type acceptance requirements of part 2 of the rules.







## Product Service Questions

For any questions about operating or installing this new Cobra product, or if parts are missing...**PLEASE CALL COBRA FIRST...** do not return this product to the store. See customer assistance on page A1.

### For Products Purchased in the U.S.A.

If your product should require factory service, please call Cobra first before sending your radio. This will ensure the fastest turn-around time on your repair. You may be asked to send your radio to the Cobra factory. It will be necessary to furnish the following to have the product serviced and returned.

- 1) For warranty repair include a copy of the original sales receipt.  
If you send the original receipt, it cannot be returned.
- 2) Send the entire product.
- 3) Enclose a detailed description of the problem along with the name and address of where the product is to be returned.
- 4) Pack radio securely to prevent damage in transit. If possible, use the original packing material.
- 5) Ship prepaid and insured by way of a traceable carrier such as United Parcel Service (UPS) or Priority Mail to avoid loss in transit to Cobra Factory Service:  
Cobra Electronics Corporation  
6500 West Cortland Street  
Chicago, Illinois 60707 U.S.A.
- 6) If the radio is under warranty, it will be repaired or exchanged depending on the model.

Please allow approximately three to four weeks before contacting Cobra for status. If the radio is out of warranty, a letter will automatically be sent informing you of the repair charge or replacement charge. If you have any questions, please call 773-889-3087 for assistance.

### For Products Purchased Outside the U.S.A.

Please contact your local dealer for product service information.